

FFT *lightweight* FibreTEC H-Frame

Highlights:

- **W3 – FLW81000821**
- **Daimler B8-Plate**
- for FibreTEC Profil SW80
- connection plate suitable for robots
- rustproof and robust thanks to high-strength aluminum
- flexible use
- standard stock item and therefore available for quick delivery

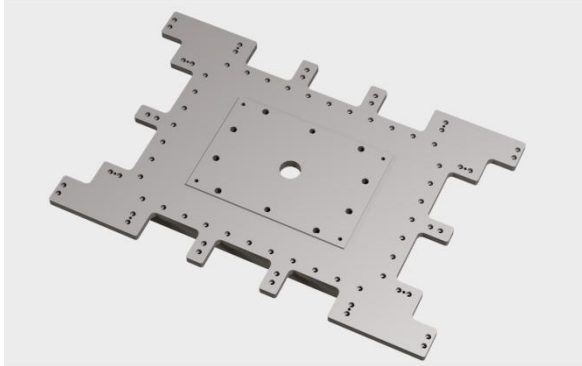

Basic Data	
Length	770 mm
Width	500 mm
Height	60 mm
Weight	15,6 kg
Hole pattern	B8-Plate (8-Hole)
Centring bore	Ø 42H7
Material	EN AW-7075

Optional centring rings in various sizes	
Ø 80, 100, 125, 145, 160	

Optional screw connection set	
Cylinder screws	ISO4762
	M6 x 30 – 10.9
Nordlock washer	NL 6
Cylinder pins	ISO08735
	6m6 x 28

Possible robot connections	
Kuka, Fanuc, ABB	

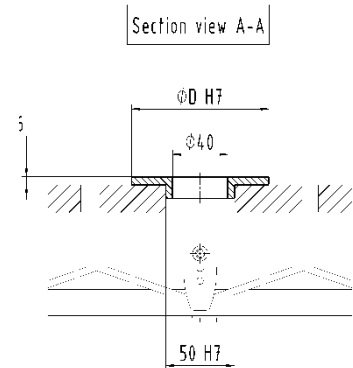
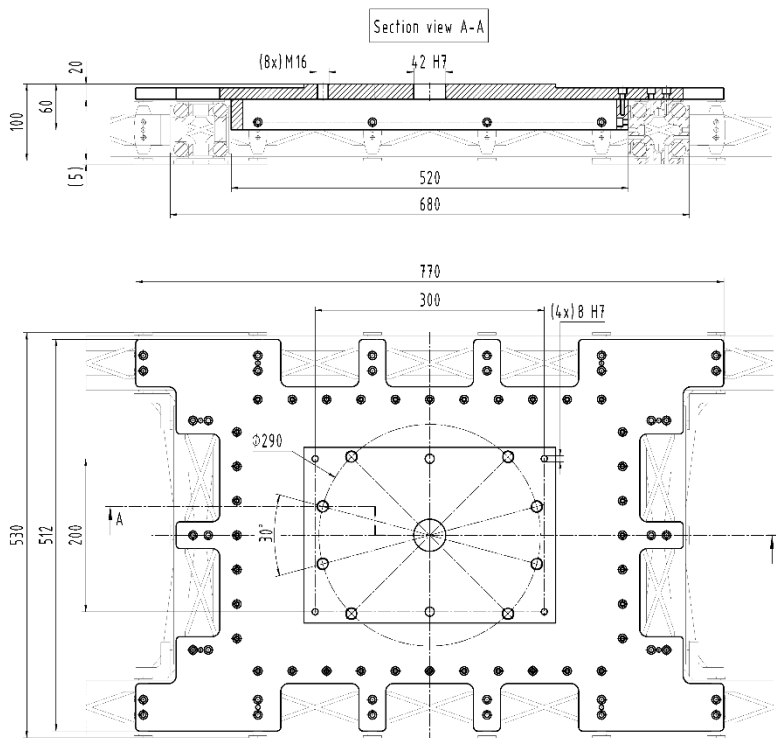

Example: Centring ring

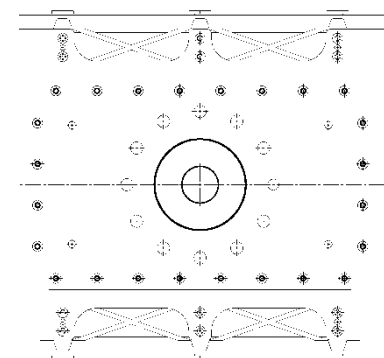

All information regarding the properties and usability of our products is provided for informational purposes only and does not constitute a guarantee of characteristics. The scope and content of our deliveries and services are determined solely by the respective contractual agreement. Technical data and illustrations are non-binding. We reserve the right to make changes at any time during technical developments.